



EDM tooling

High quality - low costs

F-Tool EDM tooling system

F-Tool delivers you from now on prefabricated blank electrodes and budget line EDM tooling systems of high quality.



EROWA EDM licence products p. 4



FT 01077
FT 01078 FT 01079
FT 01080 FT 01081
FT 01082 FT 01083
FT 01084

H-link*



FT 01999 FT 02000 FT 02001 FT 02002

EROWA link

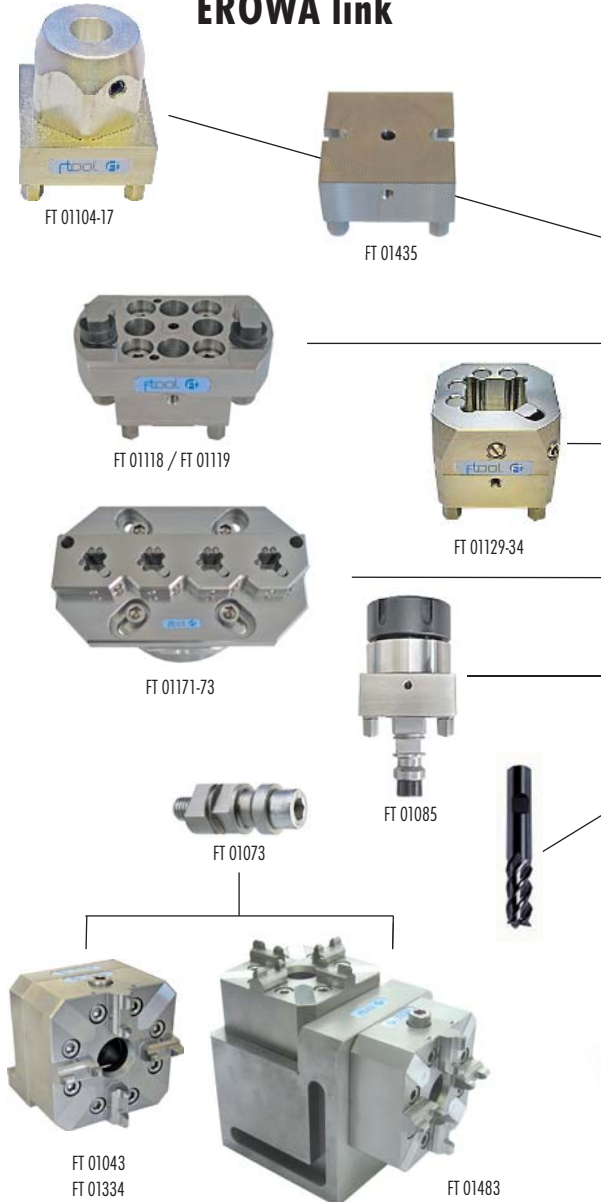

3R-link*



*H-link = compatible with Hirschmann
*3R-link = compatible with 3R

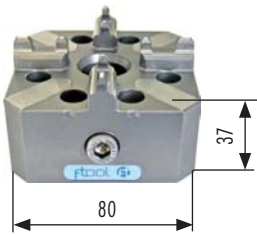

ER chuck 80P

Manual ER chuck. Hardened, stainless steel.
 For the system sizes ER 50 and 100. Hole pattern ER chuck: 8 x M6 TK Ø 61 x 45°
 Grinded taper for the power centering. Strong floating clamping mechanism.
 Tension force by hand with Allen key: 8'000 N

Article no.	Article	Quantity	Weight	Code
FT 01043	FTool ER chuck 80P	1 piece	1.60 kg	A

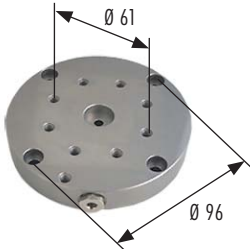

EDM adapter plate

Parallel grinded, stainless adapter plate for EDM quills. With flushing connection and M6 thread for power cable.
 Dimension: Ø 110 x 18 mm
 Hole pattern for chuck: 8 x M6 TK Ø 61 x 45°
 Hole pattern for quill: 4 x 6.5 TK Ø 96 x 90°

Article no.	Article	Quantity	Weight	Code
FT 01236	EDM adapter plate Ø 110 mm chuck 80/PIN chuck	1 piece	1.32 kg	A
FT 01829	EDM adapter plate Ø 110 mm without hole pattern Ø 96 mm	1 piece	1.32 kg	A

Delivered with screws and flushing seal.

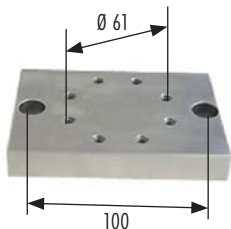

Adapter plate

Parallel grinded, stainless adapter plate, suited for machine tool tables.
 Dimension: 120 x 82 x 18 mm
 Hole pattern collet chuck: 8 x M6 TK Ø 61 x 45°
 Collet machine tool table: with brackets or 2 x M8 distance 100 mm

Article no.	Article	Quantity	Weight	Code
FT 01336	Adapter plate 120 x 82 mm chuck 80/PIN chuck	1 piece	1.40 kg	A

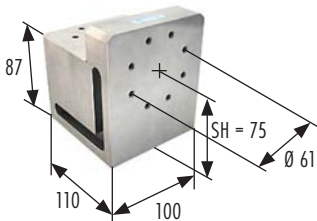

Square block

Accurate grinded square block, rustless, for the assembling of one or two ER chuck 80P (FT 01043), chuck 80 IF3R (FT 01044) or PIN center chuck (FT 01716) in vertical or horizontal position.
 For the application with brackets on divers tooling machines.
 Spindle height at horizontal installation of the chuck: 75 mm

Article no.	Article	Quantity	Weight	Code
FT 01483	Square block chuck 80/PIN chuck	1 piece	8.20 kg	A

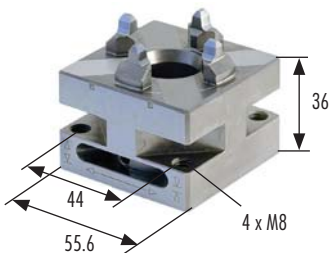

F-Tool quickchuck ITS 50

Version: ITS chuck system size 50, manual, stainless.
 Attachment: 4 x M8 bolts from the rear or 4 x M6 stud bolts with nuts.
 Application: On EDM/WEDM centers for light milling and grinding work. Max. revolutions on rotating axes 200 min⁻¹.
 Note: Clamping power 4'000 N.

Article no.	Article	Quantity	Weight	Code
FT 01041	FTool quickchuck ITS 50	1 piece	0.72 kg	B



Extension Quickchuck 50

Extension Quickchuck 50 of stainless steel.

Article no.	Article	Quantity	Weight	Code
FT 01768	Extension quickchuck 50 / L = 100 mm	1 piece	1.55 kg	B
FT 01769	Extension quickchuck 50 / L = 200 mm	1 piece	3.74 kg	B



Adapters EROWA-IF3R/IF3R-EROWA

The adapters are aligned in the area of 0.01 mm to the original system.
 System of stainless, hardened steel.

Article no.	Article	Quantity	Weight	Code
FT 01686	FTool system adapter IF3R Macro / ITS 50	1 piece	0.61 kg	B
FT 01786	FTool system adapter ITS 50 / IF3R	1 piece	0.93 kg	B

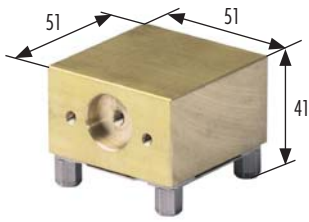

Uniblank

Version: Fitted without machining of body.
Application: To mount electrodes and workpieces of various shapes.
To fit blank: As required.

Article no.	Article	Quantity	Weight	Code
FT 01077	Uniblank without EWIS preparation	Set of 10 pieces	6.90 kg	A
FT 01078	Uniblank with EWIS preparation	Set of 10 pieces	6.70 kg	A

Delivered without chucking spigots.

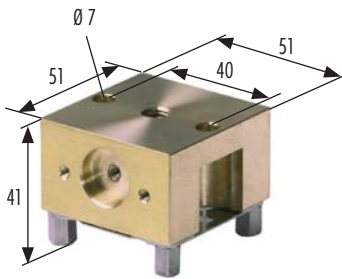

Uniplate

Version: Surface 51 x 51 mm faced, including 2 x M6 bolts for each unit.
Application: To mount electrodes and workpieces with a base surface of more than 50 mm.
To fit blank: With 2 x M6 bolts into the base surface.

Article no.	Article	Quantity	Weight	Code
FT 01079	Uniplate without EWIS preparation	Set of 10 pieces	5.80 kg	A
FT 01080	Uniplate with EWIS preparation	Set of 10 pieces	5.70 kg	A

Delivered without chucking spigots.

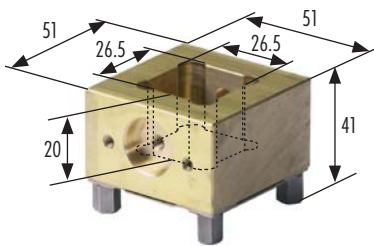

Prisround

Version: Square 26.5 mm milled. Including 2 setscrews for each unit.
Application: To mount electrodes and workpieces with a base surface of more than 50 mm.
To fit blank: Insert and tighten setscrews. If necessary, center with spacer plate FT 01092.

Article no.	Article	Quantity	Weight	Code
FT 01081	Prisround without EWIS preparation	Set of 10 pieces	5.60 kg	A
FT 01082	Prisround with EWIS preparation	Set of 10 pieces	5.40 kg	A

Delivered without chucking spigots.

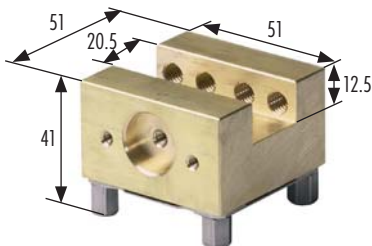

Uniholder

Version: Groove 20 mm faced. Including 2 setscrews for each unit.
Application: To mount electrodes and workpieces with shaft sizes of up to 20 mm.
To fit blank: Insert and tighten setscrews. If necessary, center with spacer plate FT 01092.

Article no.	Article	Quantity	Weight	Code
FT 01084	Uniholder without EWIS preparation	Set of 10 pieces	5.60 kg	A
FT 01083	Uniholder with EWIS preparation	Set of 10 pieces	5.50 kg	A

Delivered without chucking spigots.



F-Tool ER adapter

This adapter plate is overwinded parallel in the system and provides an insertion of electrodes, work pieces and appliances.
Corrosion-resistant.

Hole distance with 2 x M6 screws: 40 mm

Article no.	Article	Quantity	Weight	Code	Price CHF
FT 01435	FTool ER-plate EWIS	Set of 10 pieces	4.50 kg	A	660.00



Collet chuck holder with EROWA interface

Specification: Parameter EROWA ITS 50 or on 3R basis element.
Application: For collet chucks ETS32. Collet chuck Look at p. 21.

Article no.	Article	Quantity	Weight	Code
FT 01085	FTool collet chuck holder ETS32 / EWIS	1 piece	1.16 kg	A
FT 02017	Acorn nut M40 x 1.5 mm ETS32	1 piece		B

Delivered with chucking spigot F/A EDM FT 01073 without EWIS chip FT 01170.

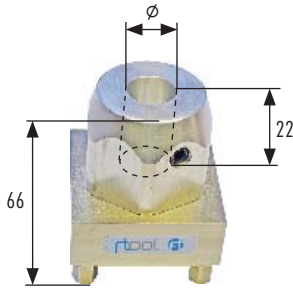

F-Tool holder with EROWA interface

Electrode holder, equipped with the repeat accurate ITS centering plate 50, assembled on the premium, stainless high-grade steel-basis plate. Incl. aluminium application for the shaft collet of divers diameters.

Adapted for clamping of copper- and graphite blanks and for high-precision handling of electrodes in the ITS clamping system and for the following application on the EDM plant.

The length of H = 66 mm has the advantage of an optimal sight when setting up and that shorter electrodes can be inserted, so the barrel chuck doesn't dip into the dielectric fluid.

Article no.	Article	Quantity	Weight	Code
FT 01104	FTool holder Ø 10 mm ER	Set of 10 pieces	5.60 kg	A
FT 01105	FTool holder Ø 10 mm EWIS	Set of 10 pieces	5.60 kg	A
FT 01106	FTool holder Ø 12 mm ER	Set of 10 pieces	5.60 kg	A
FT 01107	FTool holder Ø 12 mm EWIS	Set of 10 pieces	5.60 kg	A
FT 01108	FTool holder Ø 16 mm ER	Set of 10 pieces	5.50 kg	A
FT 01109	FTool holder Ø 16 mm EWIS	Set of 10 pieces	5.50 kg	A
FT 01110	FTool holder Ø 20 mm ER	Set of 10 pieces	5.40 kg	A
FT 01111	FTool holder Ø 20 mm EWIS	Set of 10 pieces	5.40 kg	A
FT 01112	FTool holder Ø 26 mm ER	Set of 10 pieces	5.30 kg	A
FT 01113	FTool holder Ø 26 mm EWIS	Set of 10 pieces	5.30 kg	A
FT 01114	FTool holder Ø 30 mm ER	Set of 10 pieces	5.30 kg	A
FT 01115	FTool holder Ø 30 mm EWIS	Set of 10 pieces	5.30 kg	A
FT 01116	FTool holder mixed set ER, of 2 x Ø 10 / 12 / 16 / 20 / 26 mm	Set of 10 pieces	5.50 kg	A
FT 01117	FTool holder mixed set EWIS, of 2 x Ø 10 / 12 / 16 / 20 / 26 mm	Set of 10 pieces	5.50 kg	A

ER = EROWA basis **without** EWIS preparation. EWIS = EROWA basis **with** EWIS preparation.

Delivered without chucking spigot.

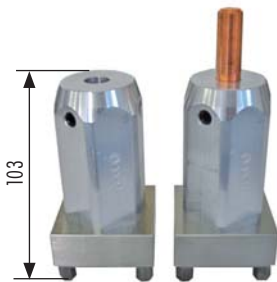

F-Tool holder Ø X mm EWIS special length

Electrode holder, equipped with the repeat accurate ITS centering plate 50, assembled on the premium, stainless high-grade steel-basis plate. Incl. aluminium application for the shaft collet of divers diameters.

→ On customer request.

Article no.	Article	Quantity	Weight	Code
FT 01683	FTool holder Ø X mm EWIS special length	Set of 10 pieces	6.75 kg	A

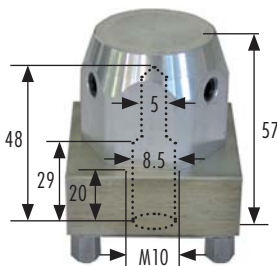

F-Tool holder ER without hole

The holder is prepared with lateral clamping screws M6. The central drill can be bored up optionally.

- Delivered without chucking spigot.

Article no.	Article	Quantity	Weight	Code
FT 01461	FTool holder ER without hole	Set of 10 pieces	5.63 kg	A
FT 01473	FTool holder D40 without hole / 6 x M6	Set of 10 pieces	5.10 kg	A

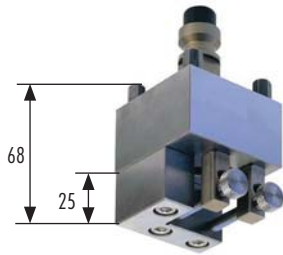

V-block holder stainless

Specification: Hardened and grinded surface of prism, 10 mm +/- 0.005 mm out of the centre.
Application: Clamp of electrodes with accurate machined shank.

Article no.	Article	Quantity	Weight	Code
FT 01087	V-block holder stainless EWIS	1 piece	1.10 kg	A

Delivered with chucking spigot F/A EDM FT 01073.



UniV holder

For the flexible clamping of round and square electrodes.

Article no.	Article	Quantity	Weight	Code
FT 01127	FTool UniV holder 58 x 80 mm ER	1 piece	1.60 kg	A
FT 01128	FTool UniV holder 58 x 80 mm IF3R	1 piece	1.94 kg	A

Delivered without chucking spigot.

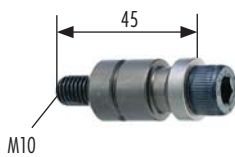

Chucking spigot F/M EDM

Version: Fixed type, manual. Bolt, length 45 mm, with flushing hole.
Application: In ITS electrode holders.

Article no.	Article	Quantity	Weight	Code
FT 01072	Chucking spigot F/M EDM manual with flushing	Set of 10 pieces	0.83 kg	A

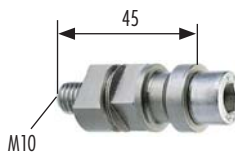

Chucking spigot F/A EDM

Version: Fixed type, automatic. Bolt, length 45 mm, with flushing hole.
Application: On all electrode holders that are changed automatically.

Article no.	Article	Quantity	Weight	Code
FT 01073	Chucking spigot F/A EDM automatic with flushing	Set of 10 pieces	0.72 kg	A

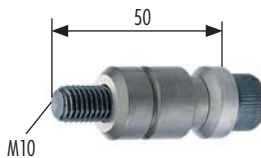

Chucking spigot F/M long without flushing

Version: Fixed type, manual. Bolt 12.9, length 50 mm, without flushing hole.
Application: In pallets for chip-cutting machining processes.

Article no.	Article	Quantity	Weight	Code
FT 01074	Chucking spigot F/M long without flushing	Set of 10 pieces	0.91 kg	A



Compact chucking spigot combi

Application: To accommodate all the compact electrodes and electrode holders in ITS compact-combi chucks and electrode changers. For handling with the EROWA combi gripper.

Article no.	Article	Quantity	Weight	Code
FT 01089	Compact chucking spigot combi	Set of 10 pieces	0.53 kg	A

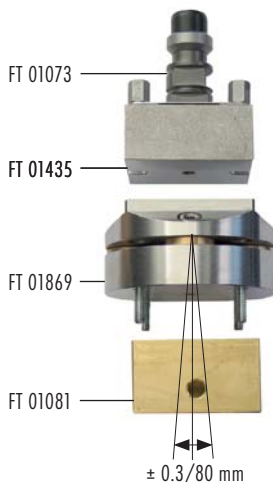

F-Tool EDM swivel head Ø 72 mm

The F-Tool swivel head can be adjusted independently in levels. Made of corrosion-resistant, hardened stainless steel. The swivel head can be utilized as a pendulum holder on the EDM machines and the wire EDM machines.

Article no.	Article	Quantity	Weight	Code
FT 01869	FTool EDM swivel head Ø 72 mm	1 piece	0.96 kg	A

All EROWA standard holder can be assembled on the EDM swivel head Ø 72, after removal of the centering plate 50.

Installation examples, see p. 26.

EROWA link Compact



Compact Holder

Electrode holders for different diameters mounted on system EROWA compact.

Article no.	Article	Quantity	Weight	Code
FT 01181	Compact holder 8 mm	Set of 10 pieces	1.40 kg	A
FT 01182	Compact holder 10 mm	Set of 10 pieces	1.40 kg	A
FT 01183	Compact holder 12 mm	Set of 10 pieces	1.40 kg	A
FT 01184	Compact holder 16 mm	Set of 10 pieces	1.40 kg	A
FT 01185	Compact holder 20 mm	Set of 10 pieces	1.40 kg	A
FT 01235	Compact holder mixed set, of 2 x 8 / 10 / 12 / 16 / 20 mm	Set of 10 pieces	1.40 kg	A



Compact slot holder

Electrode holder with slot mounted on system EROWA compact.

Article no.	Article	Quantity	Weight	Code
FT 01000	Compact slot 12 mm	Set of 10 pieces	1.90 kg	A



Compact square

Square electrode holder mounted on system EROWA compact.

Article no.	Article	Quantity	Weight	Code
FT 01329	Compact square 10	1 piece	0.29 kg	A
FT 01330	Compact square 10	Set of 10 pieces	2.90 kg	A
FT 01054	Compact square 15	1 piece	0.40 kg	A
FT 01055	Compact square 15	Set of 10 pieces	3.60 kg	A

Universal-Electrode holder

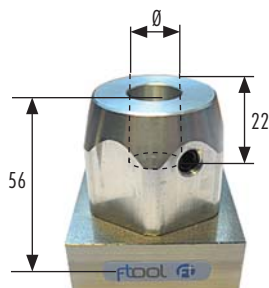

F-Tool holder prepared for 3R-651.7E-XS interface plates

Electrode holders with stainless steel base plate, incl. aluminium-insert for shaft collets of miscellaneous diameters.

Article no.	Article	Quantity	Weight	Code
FT 01227	FTool holder Ø 10 mm D40/M6	Set of 10 pieces	5.06 kg	A
FT 01228	FTool holder Ø 12 mm D40/M6	Set of 10 pieces	5.06 kg	A
FT 01229	FTool holder Ø 16 mm D40/M6	Set of 10 pieces	5.00 kg	A
FT 01230	FTool holder Ø 20 mm D40/M6	Set of 10 pieces	4.93 kg	A
FT 01316	FTool holder Ø 26 mm D40/M6	Set of 10 pieces	5.00 kg	A
FT 01231	FTool holder Ø 30 mm D40/M6	Set of 10 pieces	4.75 kg	A
FT 01232	FTool holder mixed set D40/M6, of 2 x Ø 10 / 12 / 16 / 20 / 26 mm	Set of 10 pieces	5.00 kg	A

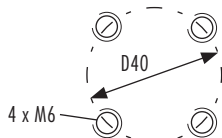

Delivered without chucking spigot and without interface IF3R.



Electrode holder

Brazen electrode holder with hole pattern 4 x M6 on pitch circle 40 mm. For the assembling of IF3R reference elements.

Article no.	Article	Quantity	Weight	Code
FT 01912	Uniholder 20 D40 M6 with slot width 20 mm	1 piece	0.48 kg	B
FT 01913	Prisround 25 D40 M6 with opening 25 x 25 mm	1 piece	0.48 kg	B

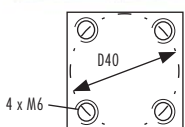

F-Tool chuck 80 IF3R

Manual chuck made by F-Tool for 3R collet. Stainless. Strong, floating gripping mechanism.
Clamping force by hand with Allen key: 5'000 - 8'000 N

Article no.	Article	Quantity	Weight	Code
FT 01044	FTool chuck 80 IF3R	1 piece	0.93 kg	A

→ Delivered with miscellaneous screw material and Allen key

EDM adapter plate (details on page 3)

Article no.	Article	Quantity	Weight	Code
FT 01236	EDM adapter plate Ø 110 mm chuck 80/PIN chuck	1 piece	1.32 kg	A
FT 01829	EDM adapter plate Ø 110 mm without hole pattern Ø 96 mm	1 piece	1.32 kg	A

Adapter plate (details on page 3)

Article no.	Article	Quantity	Weight	Code
FT 01336	Adapter plate 120 x 82 mm chuck 80/PIN chuck	1 piece	1.40 kg	A

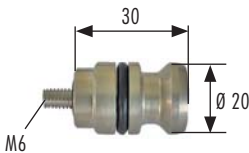

Square block (details on page 3)

Article no.	Article	Quantity	Weight	Code
FT 01483	Square block chuck 80/PIN chuck	1 piece	8.20 kg	A

F-Tool spigot 20 MS short M6 IF3R

Version: Type Ø 20 short, M6 for helicoil in basic plate IF3R, rustless, the screw is provided with a central flushing hole.
Application: For the manual application of F-Tool basic plates IF3R (FT 01135) in the F-Tool chuck 80 IF3R (FT 01044).

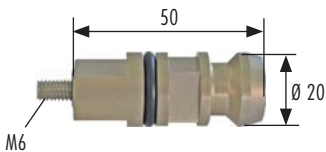
Article no.	Article	Quantity	Weight	Code
FT 01224	FTool spigot 20 MS short M6 IF3R	Set of 10 pieces	0.76 kg	A

F-Tool spigot 20 ATC long M6 IF3R

Version: Type Ø 20 long, M6 for helicoil in basic plate IF3R, rustless, the screw is provided with a central flushing hole.
Application: For the manual or automatic application of F-Tool basic plates IF3R (FT 01135) in the MACRO chuck.

Article no.	Article	Quantity	Weight	Code
FT 01223	FTool spigot 20 ATC long M6 IF3R	Set of 10 pieces	0.91 kg	A

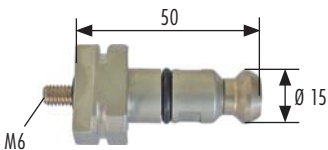
F-Tool spigot 15 MC/ATC M6 IF3R

Version: Type Ø 15, M6 for helicoil in basic plate IF3R, rustless, the screw is provided with a central flushing hole.
Application: For the manual or automatic application of F-Tool basic plates IF3R (FT 01135) in the MACRO/Combi chuck.

Article no.	Article	Quantity	Weight	Code
FT 01225	FTool spigot 15 MC/ATC M6 IF3R (Macro/Combi)	Set of 10 pieces	1.00 kg	A

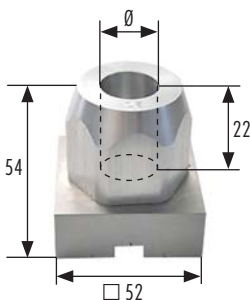

F-Tool holder with basic plate IF3R

Electrode holders, equipped with the rustless F-Tool IF3R high-grade steel interface plate made by F-Tool. Incl. aluminium insert for the shaft collet of miscellaneous diameters. Appropriate for clamping of copper and graphite blanks and for the high-precision machining of electrodes in the F-Tool chuck 80 IF3R (FT 01044) or MACRO chuck and for the following application on EDM machines.

Article no.	Article	Quantity	Weight	Code
FT 01136	FTool holder Ø 10 mm IF3R (compatible with 3R)	Set of 10 pieces	4.70 kg	A
FT 01137	FTool holder Ø 12 mm IF3R (compatible with 3R)	Set of 10 pieces	4.70 kg	A
FT 01138	FTool holder Ø 16 mm IF3R (compatible with 3R)	Set of 10 pieces	4.60 kg	A
FT 01139	FTool holder Ø 20 mm IF3R (compatible with 3R)	Set of 10 pieces	4.50 kg	A
FT 01317	FTool holder Ø 26 mm IF3R (compatible with 3R)	Set of 10 pieces	4.40 kg	A
FT 01140	FTool holder Ø 30 mm IF3R (compatible with 3R)	Set of 10 pieces	4.30 kg	A
FT 01226	FTool holder mixed set IF3R, of 2 x 10 / 12 / 16 / 20 / 26 mm	Set of 10 pieces	4.60 kg	A

Delivered without spigots.

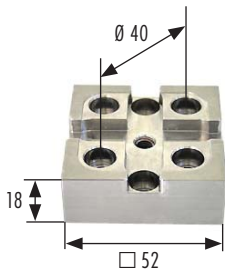
Recommended spigots, according to chuck: FT 01223 / FT 01224 / FT 01225



F-Tool basic plate IF3R

The F-Tool basic plates IF3R made by F-Tool are standard adapters for miscellaneous collets or for the direct clamping of electrode blanks. The reference slot for the IF3R chucks is produced in high-precision.

Material: rustless steel

Hole pattern: 6 x Ø 6.5 mm on reference circle diameter 40 mm

Article no.	Article	Quantity	Weight	Code
FT 01135	FTool basic plate IF3R	Set of 10 pieces	3.30 kg	A

Delivered without spigots.

Recommended spigots, according to chuck: FT 01223 / FT 01224 / FT 01225

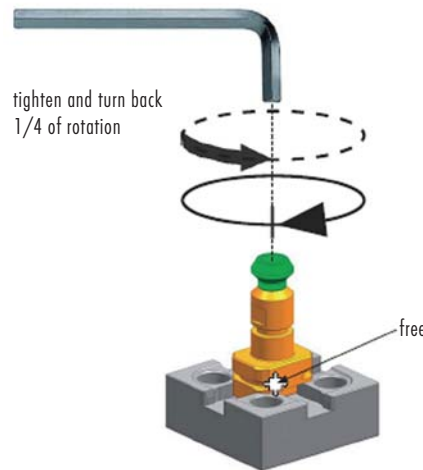

Collet chuck holder with IF3R

Collet chuck holder ETS32, rust resistant, assembled with sealing washer on a F-Tool basic plate IF3R. Compatible with 3R-MACRO.

Article no.	Article	Quantity	Weight	Code
FT 01237	FTool collet chuck holder ETS32 / IF3R	1 piece	1.52 kg	A
FT 02017	Acorn nut M40 x 1.5 mm ETS32	1 piece		B

Delivered without chucking spigot. Collet chucks, see p. 21.

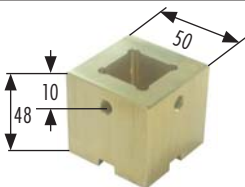

Brass holder IF3R

F-Tool brass holder for the collet of square blanks 15. Compatible with chucks of the system 3R. The square collet was manufactured in reference position.

Article no.	Article	Quantity	Weight	Code
FT 01995	Square 15 Brass holder IF3R	Set of 10 pieces	8.50 kg	A

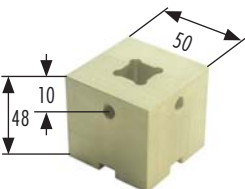

Brass holder IF3R

F-Tool brass holder for the collet of square blanks 25. Compatible with chucks of the system 3R. The square collet was manufactured in reference position.

Article no.	Article	Quantity	Weight	Code
FT 01996	Square 25 Brass holder IF3R	Set of 10 pieces	7.40 kg	A

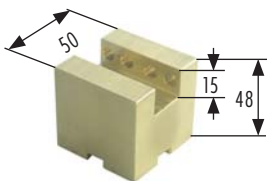

Brass holder IF3R

F-Tool brass holder for the collet of electrode blanks. Compatible with chucks of the system 3R. Clamping width up to 20 mm.

Article no.	Article	Quantity	Weight	Code
FT 01997	UNI Brass holder 20 IF3R	Set of 10 pieces	7.90 kg	A

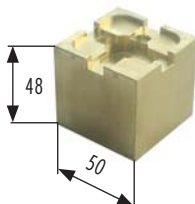

Brass holder IF3R

F-Tool brass holder for the collet of electrode blanks. Compatible with chucks of the system 3R. The clamping form and size can be attached individually on the holder.

Article no.	Article	Quantity	Weight	Code
FT 01998	UNI-Blank Brass holder IF3R	Set of 10 pieces	9.32 kg	A

NEW!

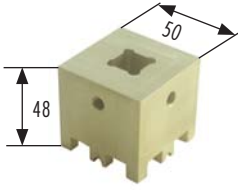

Brass holder IF-H

F-Tool brass holder for the collet of square blanks 15. Compatible with chucks of the system Hirschmann.

Article no.	Article	Quantity	Weight	Code
FT 01999	Square 15 Brass holder IF-H	Set of 10 pieces	7.77 kg	A

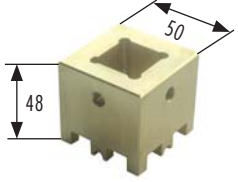

Brass holder IF-H

F-Tool brass holder for the collet of square blanks 25. Compatible with chucks of the system Hirschmann.

Article no.	Article	Quantity	Weight	Code
FT 02000	Square 25 Brass holder IF-H	Set of 10 pieces	6.90 kg	A

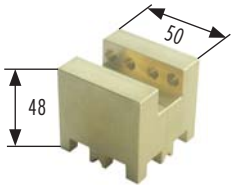

Brass holder IF-H

F-Tool brass holder for the collet of electrode blanks. Compatible with chucks of the system Hirschmann. Clamping width up to 20 mm.

Article no.	Article	Quantity	Weight	Code
FT 02001	UNI Brass holder 20 IF-H	Set of 10 pieces	7.08 kg	A

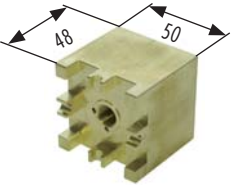

Brass holder IF-H

F-Tool brass holder for the collet of electrode blanks. Compatible with chucks of the system Hirschmann. The clamping form and size can be attached individually on the holder.

Article no.	Article	Quantity	Weight	Code
FT 02002	UNI-Blank Brass holder IF-H	Set of 10 pieces	8.80 kg	A

The F-Tool UniClamp reduces the consumption of electrode material

Simply saw the graphite, clamp it into the UniClamp, machine and erode.

All F-Tool UniClamp are from A like alignment to Z like Z-support identical. Electrodes can be removed from the UniClamp and re-clamped in reference position. The short clamping height reduces the consumption of electrode material.

Less set-up time, less consumption of electrode material, less costs

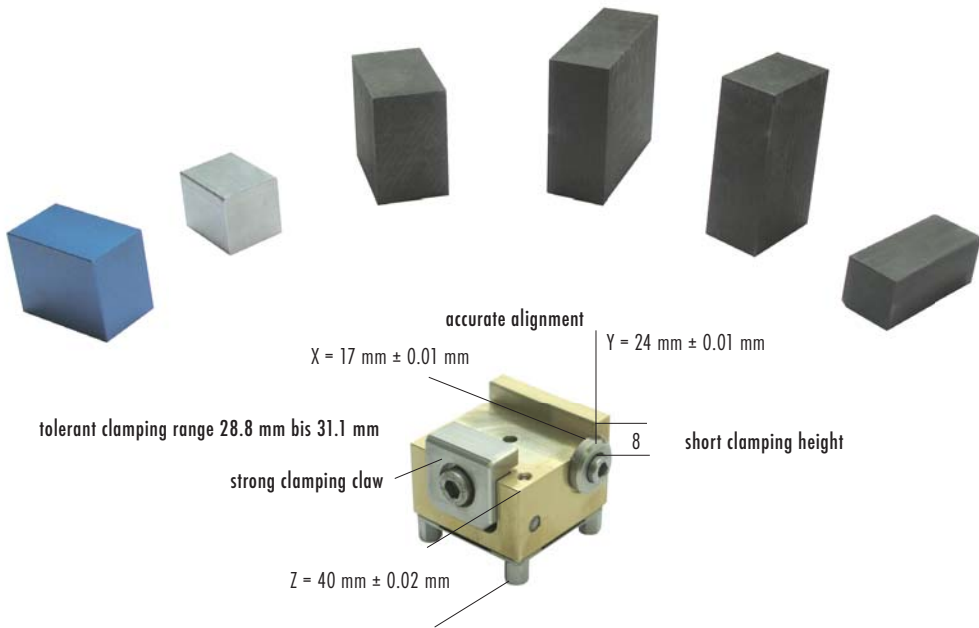

F-Tool UniClamp

The F-Tool UniClamp are new, basically developed as electrode holders. The strong clamping claw pushes the electrode to the reference surface and holds it firmly in position. Electrode blanks can simply be sawed off and clamped quickly. Also completed electrodes can be clamped permanently on different UniClamp in reference position. The F-Tool UniClamp is suited as well for clamping and machining of precision parts.

Article no.	Article	Quantity	Weight	Code
FT 01953	FTool UniClamp ER-30	1 piece	0.72 kg	A
FT 01957	FTool UniClamp ER-30	Set of 10 pieces	6.84 kg	A



F-Tool UniClamp TR30 (compatible with 3R)

The F-Tool UniClamp are new, basically developed as electrode holders. The strong clamping claw pushes the electrode to the reference surface and holds it firmly in position. Electrode blanks can simply be sawed off and clamped quickly. Also completed electrodes can be clamped permanently on different UniClamp in reference position. The F-Tool UniClamp is suited as well for clamping and machining of precision parts.

Article no.	Article	Quantity	Weight	Code
FT 01954	FTool UniClamp TR-30	1 piece	0.82 kg	A
FT 01958	FTool UniClamp TR-30	Set of 10 pieces	7.88 kg	A

RefTool holder

The RefTool holder brings completely new possibilities to clamp electrodes fast and economic.

1. The function

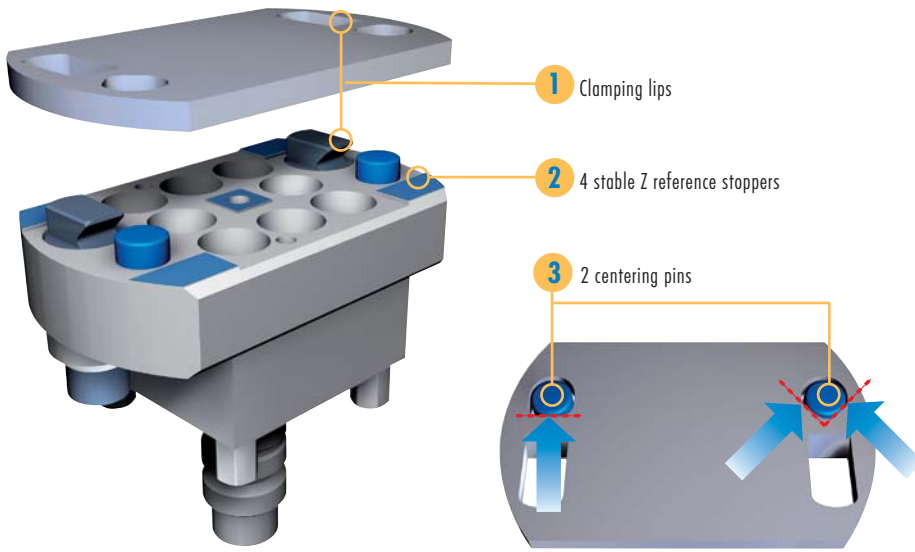

2. Economic electrode holders

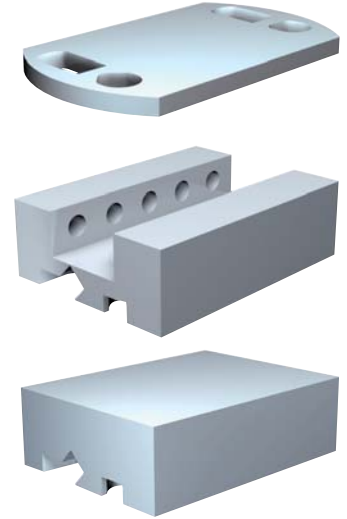

3. The application

3.1. RefTool graphite adapter

- Screw the RefTool graphite adapter on the graphite blank
- Cut and use the electrode in the system
- Store the electrodes together with the economic graphite adapter



3.2. RefTool graphite clamp

- Clamp the graphite blank into the clamp
- Cut and use the electrode in the system
- Store the electrodes with the economic graphite clamp



3.3. RefTool WEDM adapter
RefTool free clamp

- The electrode can be cut in reference position by wire EDM through the RefTool WEDM adapter or the free clamp

- Complex form electrode-cut by WEDM



RefTool WEDM adapter

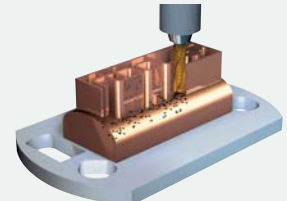

RefTool free clamp

- Complex profiles for serial jobs cut by WEDM

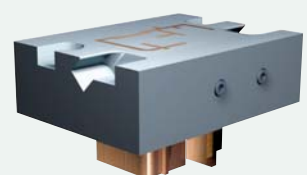
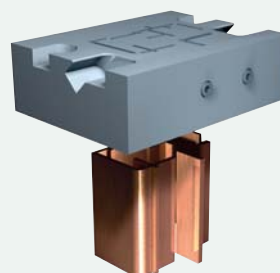
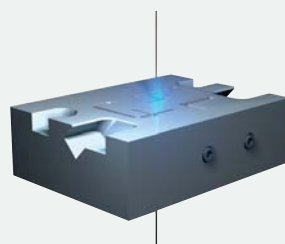

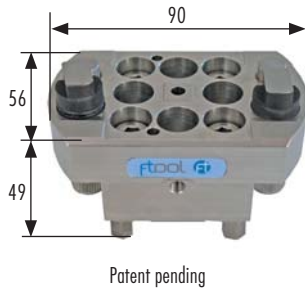

RefTool holder with EROWA interface

The RefTool holder is a new developed reference holder of F-Tool. The RefTool holder is suited mainly for the retaining of divers electrodes, particularly of inexpensive graphite collets.

The RefTool holder is assembled on the repeat accurate, premium, stainless high-grade steel-basis plate.

- Fast electrode clamping by adapted, standardised grandeur specifications (hole pattern or clamping nut)
- Uttermost inexpensive reference holders
- System accuracy of ITS (transfer from clamp to clamp) < 2 µm
- System accuracy of the reference holders < 0.01 mm (clamping / unclamping of the electrodes)

Article no.	Article	Quantity	Weight	Code
FT 01118	RefTool holder EWIS	1 piece	1.00 kg	A
FT 01119	RefTool holder EWIS	Set of 5 pieces	5.00 kg	A

Delivered without chucking spigot.

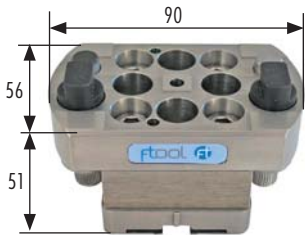

RefTool holder with IF3R interface

Equipped with reference element 3R. Compatible with 3R-MACRO.

Article no.	Article	Quantity	Weight	Code
FT 01141	RefTool holder IF3R (compatible with 3R)	1 piece	0.97 kg	A
FT 01142	RefTool holder IF3R (compatible with 3R)	Set of 5 pieces	5.20 kg	A

Delivered without spigot.



RefTool IF pallet

With the RefTool IF pallet, electrodes can be handled on the RefTool holders in reference position with the wire EDM machine. The RefTool IF pallet is delivered completely with screws and keys.

Pallet dimension: 130 x 100 x 14 mm

Article no.	Article	Quantity	Weight	Code
FT 01363	RefTool IF pallet 14 mm	1 piece	1.34 kg	W

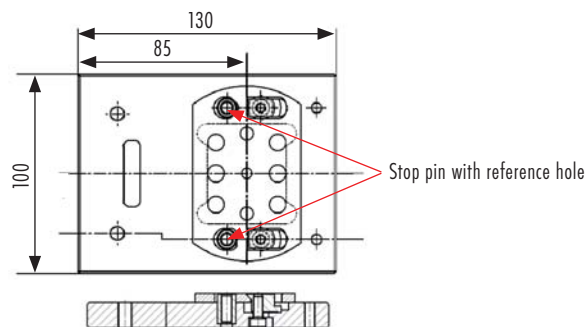

RefTool setup

With the RefTool setup, the RefTool adapters can be assembled and disassembled comfortable on the RefTool holders.

Article no.	Article	Quantity	Weight	Code
FT 01123	RefTool setup	1 piece	2.45 kg	A



RefTool checking plate

The RefTool holders undergo a severe check and are delivered system accurate ex works. After a crash or a long service it's worth to make a quality check with the RefTool checking plate.

Article no.	Article	Quantity	Weight	Code
FT 01122	RefTool checking plate (grinded and hardened)	1 piece	0.83 kg	A

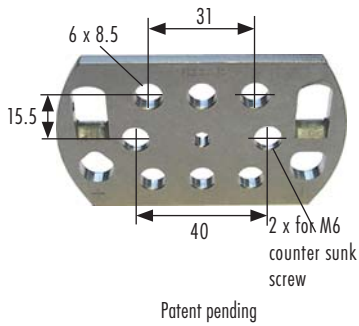

RefTool graphite adapter

The RefTool graphite adapter can be screwed, according to the hole pattern, with two or several M8 screws on a prepared graphite blank and can afterwards be handled reference based and system accurate.
The RefTool adapters are very inexpensive and functional.
→ Positioning / repeat accuracy < 0.01 mm

Article no.	Article	Quantity	Weight	Code
FT 01120	RefTool adapter with hole pattern	Set of 20 pieces	3.20 kg	A

Delivered with 2 x M8 screws and 2 x M6 countersunk screws.

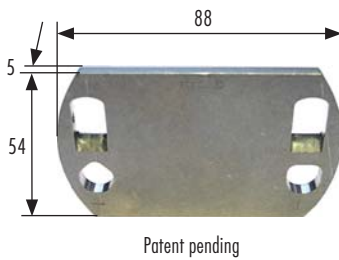

RefTool WEDM adapter

With the RefTool WEDM adapter copper plates, for example, can be tightened and with the cutting erosion machine through the plate be handled in reference position. In the next following step, the rough-worked electrodes can be removed from the cutting machine, followed up in the RefTool holder and without loss of time, inserted on the EDM machine in reference position.
→ Positioning / repeat accuracy < 0.01 mm

Article no.	Article	Quantity	Weight	Code
FT 01121	RefTool adapter without hole pattern	Set of 20 pieces	3.10 kg	A

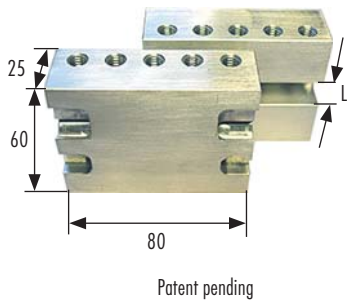

RefTool graphite clamp (aluminium)

The RefTool graphite clamp is uttermost inexpensive and perfect for the collet of graphite blanks.
→ Tailor graphite → clamp → in a matter of seconds finished for the manufacturing process

Article no.	Article	Quantity	Weight	Code
FT 01124	RefTool graphite clamp L = 13 mm alu	Set of 16 pieces	4.60 kg	A
FT 01125	RefTool graphite clamp L = 26 mm alu	Set of 16 pieces	4.00 kg	A
FT 01126	RefTool graphite clamp L = 33 mm alu	Set of 16 pieces	3.72 kg	A
FT 01053	RefTool clamp mixed set, of 4 x L = 0 / 13 / 26 / 33 mm alu	Set of 16 pieces	4.40 kg	A

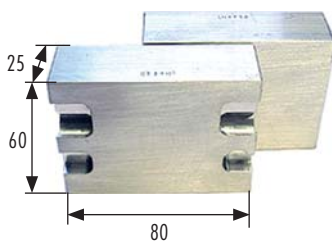

RefTool free clamp (aluminium)

The RefTool free clamp aluminium can be freely prepared for the different shapes of electrodes. It can also be prepared for special electrode shapes and can be cut by wire EDM machine.

Article no.	Article	Quantity	Weight	Code
FT 01052	RefTool free clamp alu	Set of 16 pieces	5.20 kg	A

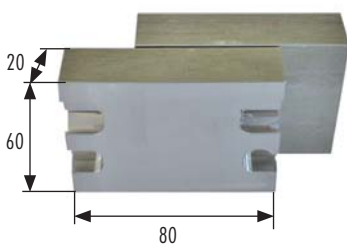

RefTool free clamp (steel)

The RefTool free clamp steel can be freely prepared for the different shapes of electrodes. It can also be prepared for special electrode shapes and can be cut by wire EDM machine.

Article no.	Article	Quantity	Weight	Code
FT 01221	RefTool free clamp steel	Set of 16 pieces	11.30 kg	A

F-Tool square clamp

The new dimension for EDMing.
Simple, accurate and extremely economic.

1. The function

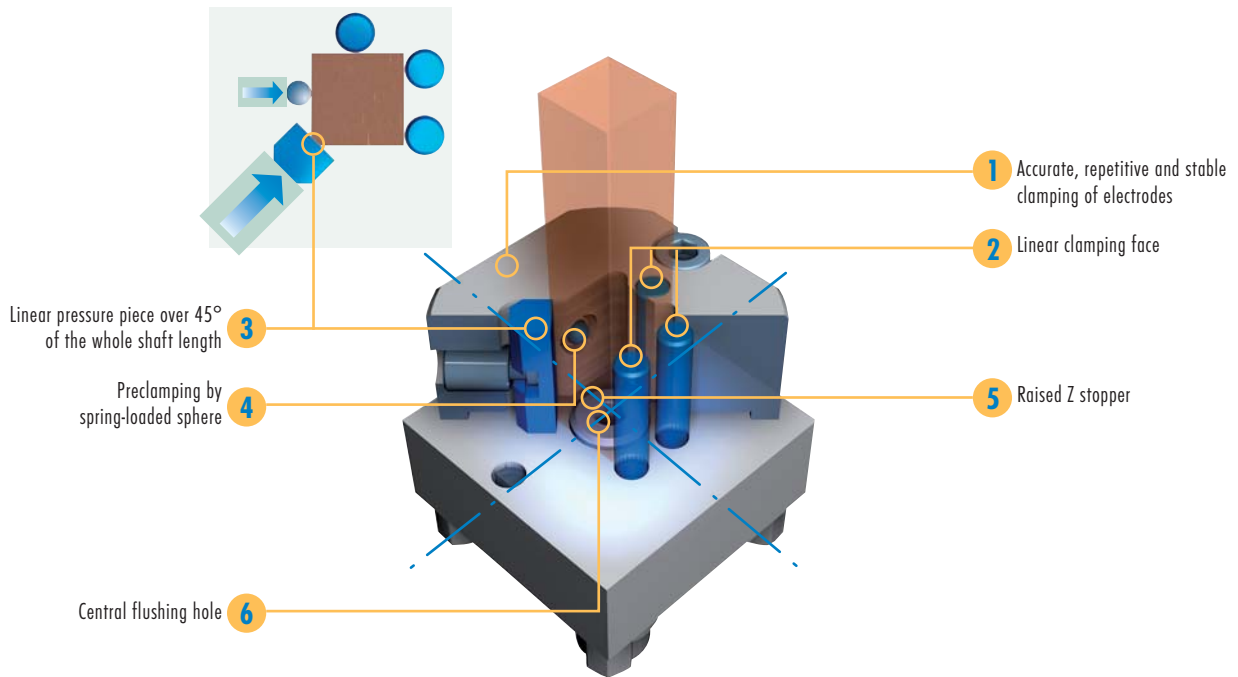

2. The application

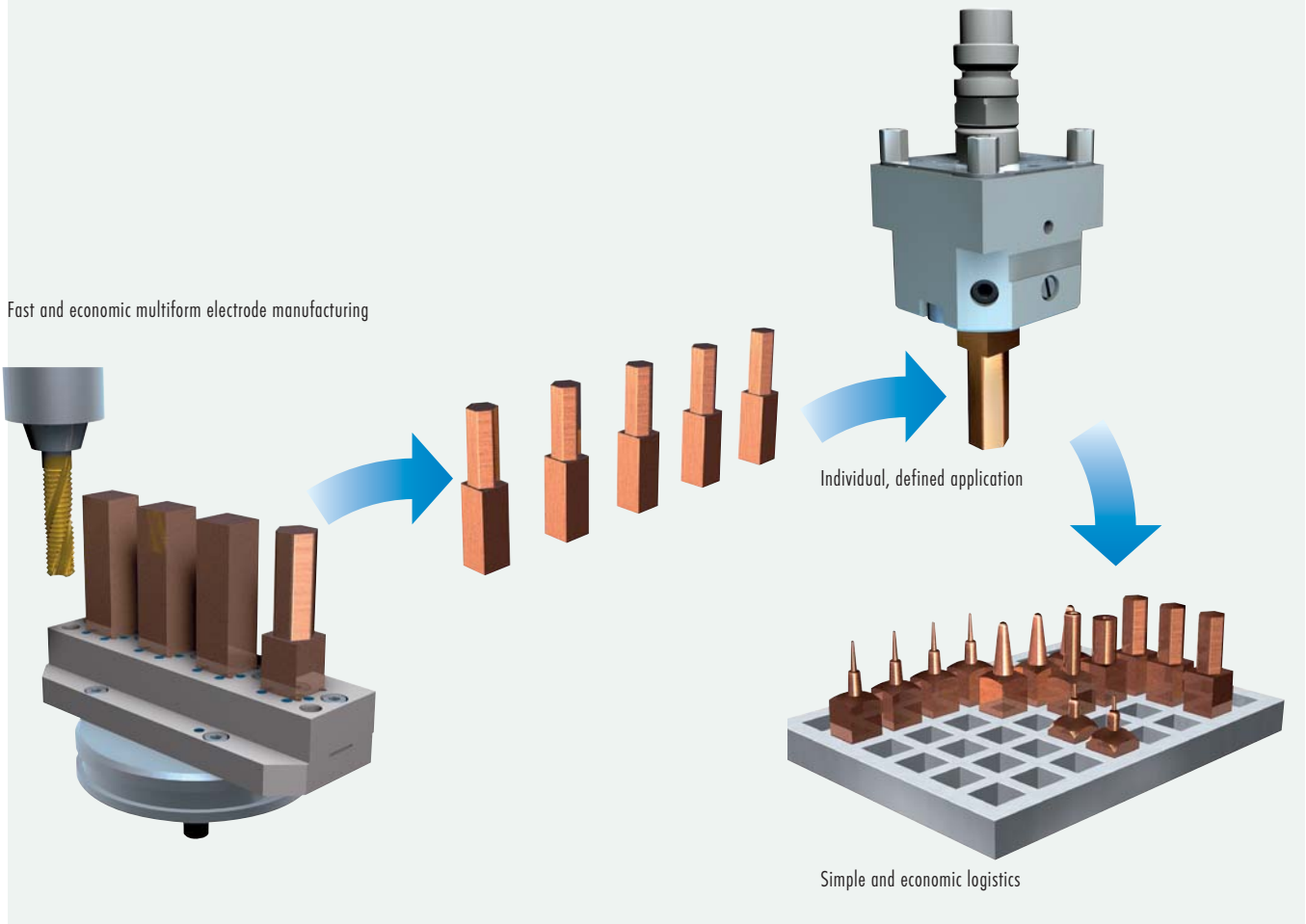



Z = 32/0-0.04 mm

Patent pending

F-Tool square clamp with EROWA interface

The new design of the F-Tool square clamp has many advantages.

- Well in price
- Uttermost repeat accuracy
- Non-sensitive to soil and corrosion resistant
- Solid
- Positioning / repeat accuracy of the electrode blanks < 0.01 mm
- New are the dimensions of 30 x 30 mm

Article no.	Article	Quantity	Weight	Code
FT 01129	FTool 15 square clamp EWIS	1 piece	0.93 kg	A
FT 01130	FTool 15 square clamp EWIS	Set of 10 pieces	8.80 kg	A
FT 01131	FTool 25 square clamp EWIS	1 piece	0.84 kg	A
FT 01132	FTool 25 square clamp EWIS	Set of 10 pieces	8.05 kg	A
FT 01133	FTool 30 square clamp EWIS	1 piece	0.86 kg	A
FT 01134	FTool 30 square clamp EWIS	Set of 10 pieces	8.14 kg	A

Delivered without chucking spigot.

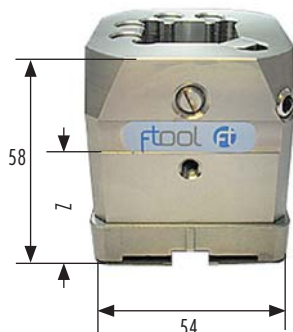

Z = 32/0-0.04 mm

F-Tool square clamp with IF3R

→ Provided with reference element IF3R.

→ Appropriate for 3R standard spigots

Article no.	Article	Quantity	Weight	Code
FT 01143	FTool 15 square clamp IF3R	1 piece	1.02 kg	A
FT 01144	FTool 15 square clamp IF3R	Set of 10 pieces	9.83 kg	A
FT 01145	FTool 25 square clamp IF3R	1 piece	0.94 kg	A
FT 01146	FTool 25 square clamp IF3R	Set of 10 pieces	9.10 kg	A
FT 01147	FTool 30 square clamp IF3R	1 piece	0.94 kg	A
FT 01148	FTool 30 square clamp IF3R	Set of 10 pieces	9.10 kg	A

Delivered without spigot.

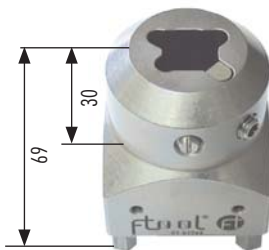

Square 15 monoblock

- Square 15 of stainless, hardened INOX steel with collet EROWA
- 3 linear stop surfaces, hardened and jig grinded
- Repeat accuracy +/- 0.005 mm, as well at changing electrodes in several holders
- Lateral flushing connection
- Prepared for EWIS
- Delivered without chucking spigot

Article no.	Article	Quantity	Weight	Code
FT 01762	Square 15 monobloc	1 piece	0.92 kg	B

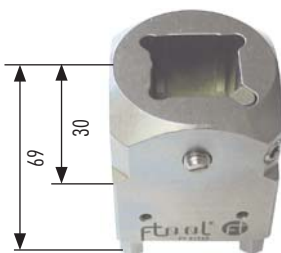

Square 25 monoblock

- Square 25 of stainless, hardened INOX steel with collet EROWA
- 3 linear stop surfaces, hardened and jig grinded
- Repeat accuracy +/- 0.005 mm, as well at changing electrodes in several holders
- Lateral flushing connection
- Prepared for EWIS
- Delivered without chucking spigot

Article no.	Article	Quantity	Weight	Code
FT 01763	Square 25 monobloc	1 piece	0.99 kg	B

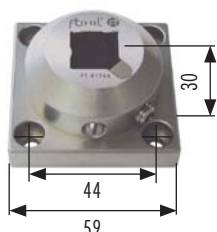

Square 15 front part

- Square front part of stainless, hardened INOX steel
- 3 linear stop surfaces, hardened and jig grinded
- Repeat accuracy +/- 0.005 mm
- For the assembling on pallets and plates for multiple clamping
- Hole pattern for 4 x M6 Ø 6.5 mm

Article no.	Article	Quantity	Weight	Code
FT 01764	Square 15 front part	1 piece	0.48 kg	B



Square 25 front part

- Square front part of stainless, hardened INOX steel
- 3 linear stop surfaces, hardened and jig grinded
- Repeat accuracy +/- 0.005 mm
- For the assembling on pallets and plates for multiple clamping
- Hole pattern for 4 x M6 \varnothing 6.5 mm

Article no.	Article	Quantity	Weight	Code
FT 01765	Square 25 front part	1 piece	0.62 kg	B



F-Tool graphite shaft clamp CIF (cross interface)

- With the shaft clamp, the prepared graphite blank's can be taken easily. Afterwards they can be inserted in reference position into the suitable Square Clamp System
- For the re-use, the electrodes prepared in reference position, can be stored economic incl. graphite shaft clamp

Note

- If you remove the shaft from the finished electrode, the positioning accuracy is warranted to only a limited extent

Article no.	Article	Quantity	Weight	Code
FT 01222	FTool graphite shaft clamp CIF 25 M6 aluminium	Set of 10 pieces	1.10 kg	A
FT 01485	FTool graphite shaft clamp CIF 25 M6 steel	1 piece	0.35 kg	A



Square15 shaft holder

With the square shaft holder, the copper consumption can be reduced to a minimum. The square shaft holder is prepared for the collet of two different diameters. The borehole is prepared with a H7 manufacturing tolerance. Other diameters can be clamped and bored by oneself in the square holder.

Article no.	Article	Quantity	Weight	Code
FT 01918	Square15 shaft holder \varnothing 4H7/ \varnothing 6H7	1 piece	0.11 kg	A
FT 01919	Square15 shaft holder \varnothing 8H7/ \varnothing 10H7	1 piece	0.09 kg	A



Injection nozzle El. Holder

Made of stainless, hardened INOX steel. For the collet in the square 15 monoblock, square clamp 15 etc.

- Infinitely adjustable from 0-90°
- Able to erode lateral drillings and nozzles.

Article no.	Article	Quantity	Weight	Code
FT 01766	Square 15 injection nozzle El. Holder \varnothing 6 mm 0-90°	1 piece	0.23 kg	B

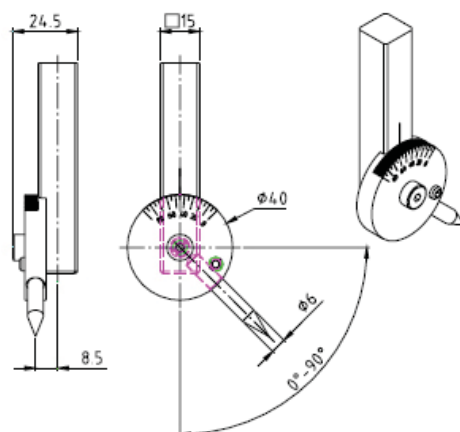

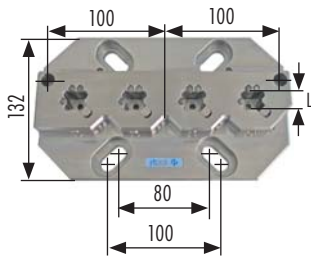

Square clamp multiplate

The square clamp multiplate is suited excellent for the rational fabrication of square electrodes. One or several multiple plates can be assembled on standard system beams.

- Rational, accurate electrode manufacturing, in grid 50 mm
- Alignment of the pallet and searching the coordinates by 2 reference holes, distance to the middle \emptyset axe 18 mm
- The square clamp multiplate can be fixed to all pallets with 40/50 mm pattern bore holes

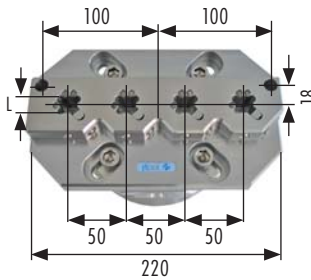
Article no.	Article	Quantity	Weight	Code
FT 01174	Square clamp 4 x L = 15 mm multiplate	1 piece	5.20 kg	A
FT 01175	Square clamp 4 x L = 25 mm multiplate	1 piece	5.01 kg	A
FT 01176	Square clamp 4 x L = 30 mm multiplate	1 piece	4.80 kg	A

Pallet 148 square clamp multiplate

The pallet 148 square clamp multiplate can, manual or automatic, inserted into the EROWA ITS clamping system. Otherwise, specification as above.

Article no.	Article	Quantity	Weight	Code
FT 01171	Pallet 148 square clamp 4 x L = 15 mm	1 piece	7.30 kg	A
FT 01172	Pallet 148 square clamp 4 x L = 25 mm	1 piece	7.02 kg	A
FT 01173	Pallet 148 square clamp 4 x L = 30 mm	1 piece	6.90 kg	A

Delivered incl. pallet 148 with centering plate 100 M8. Delivered without chucking spigot.

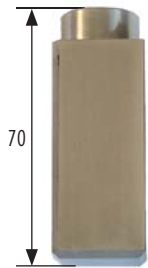
Square clamp checking rod

A periodical inspection of the square clamp holder or the check after a crash is suitable.

Article no.	Article	Quantity	Weight	Code
FT 01177	Square clamp checking rod 10	1 piece	0.17 kg	A
FT 01178	Square clamp checking rod 15	1 piece	0.22 kg	A
FT 01179	Square clamp checking rod 25	1 piece	0.43 kg	A
FT 01180	Square clamp checking rod 30	1 piece	0.58 kg	A

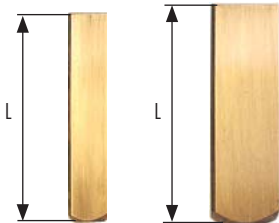
Electrode copper for square clamp

Drawn profile of EDM Copper, incl. phase 45° for the safe, direction-oriented, and with lapped stop-surface for the accurate application.

Article no.	Article	Quantity	Weight	Code
FT 01094	Square blank 15 L = 75 mm, lapped	Set of 32 pieces	4.74 kg	E
FT 01095	Square blank 25 L = 80 mm, lapped	Set of 20 pieces	8.80 kg	E
FT 01770	Electrode cu 15 x 15 mm L = 75 mm, manual grinded	Set of 32 pieces	4.83 kg	E
FT 01771	Electrode cu 25 x 25 mm L = 80 mm, manual grinded	Set of 20 pieces	8.90 kg	E
FT 01165	El.-copper 30 x 30 L = 60 mm, blank	Set of 10 pieces	4.89 kg	E
FT 01166	El.-copper 30 x 30 L = 60 mm, blank	Set of 24 pieces	11.61 kg	E

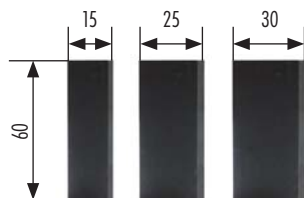
F-Tool graphite square blank

Graphite square with phase, prepared for the square clamps 15, 25 and 30 mm. EX60 for roughing up to surface quality VDI 24. EX70 for finishing up to surface quality VDI 18.

Artikel-Nr.	Artikel	Menge	Gewicht	Code
FT 01241	FTool graphite square blank 15 x 15 x 60 mm EX60	Set of 36 pieces	0.87 kg	G
FT 01242	FTool graphite square blank 15 x 15 x 250 mm EX60	Set of 2 pieces	0.20 kg	G
FT 01243	FTool graphite square blank 25 x 25 x 60 mm EX60	Set of 36 pieces	2.43 kg	G
FT 01244	FTool graphite square blank 25 x 25 x 250 mm EX60	Set of 2 pieces	0.56 kg	G
FT 01245	FTool graphite square blank 30 x 30 x 60 mm EX60	Set of 36 pieces	3.50 kg	G
FT 01246	FTool graphite square blank 30 x 30 x 250 mm EX60	Set of 2 pieces	0.81 kg	G
FT 01277	FTool graphite square blank 15 x 15 x 60 mm EX70	Set of 36 pieces	0.90 kg	G
FT 01278	FTool graphite square blank 15 x 15 x 250 mm EX70	Set of 2 pieces	0.21 kg	G
FT 01279	FTool graphite square blank 25 x 25 x 60 mm EX70	Set of 36 pieces	2.50 kg	G
FT 01280	FTool graphite square blank 25 x 25 x 250 mm EX70	Set of 2 pieces	0.58 kg	G
FT 01281	FTool graphite square blank 30 x 30 x 60 mm EX70	Set of 36 pieces	3.60 kg	G
FT 01282	FTool graphite square blank 30 x 30 x 250 mm EX70	Set of 2 pieces	0.83 kg	G

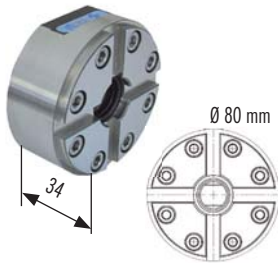

8 x hole pattern M6 Ø 61 mm

F-Tool PIN center chuck

The PIN center chuck is a compact reference system and is able for the collet of electrodes and work pieces. It's also the base of the F-Tool PIN ZeroPoint centering system. The centering, respective the positioning happens in two steps. The first step is the pre-centering with the PIN centering bolt. The precise centering is done, if the cone of the spigot is intervening on the flexible centering plate, and the piece is drawn to the clamping area. With the intervention of the PIN index 8 mm into the cross slot, the angle coat is defined.

Article no.	Article	Quantity	Weight	Code
FT 01716	FTool PIN center chuck	1 piece	1.48 kg	P
FT 01717	FTool PIN center chuck with nonius graduation	1 piece	1.54 kg	P

EDM adapter plate (details on page 3)

Article no.	Article	Quantity	Weight	Code
FT 01236	EDM adapter plate Ø 110 mm chuck 80/PIN chuck	1 piece	1.32 kg	A
FT 01829	EDM adapter plate Ø 110 mm without hole pattern Ø 96 mm	1 piece	1.32 kg	A

Adapter plate (details on page 3)

Article no.	Article	Quantity	Weight	Code
FT 01336	Adapter plate 120 x 82 mm chuck 80/PIN chuck	1 piece	1.40 kg	A

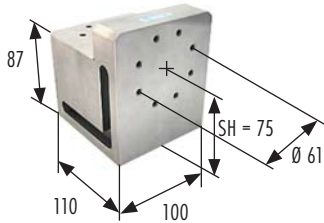
Square block (details on page 3)

Article no.	Article	Quantity	Weight	Code
FT 01483	Square block chuck 80/PIN chuck	1 piece	8.20 kg	A

F-Tool PIN center chuck IF EROWA

With the PIN center chuck IF EROWA the electrodes and work pieces can be inserted into the EROWA ITS system.

Article no.	Article	Quantity	Weight	Code
FT 01728	FTool PIN center chuck IF EROWA	1 piece	1.96 kg	P

Delivered with chucking spigot F/A EDM automatic with flushing.

F-Tool PIN center chuck IF3R

With the PIN center chuck IF3R the electrodes and work pieces can be inserted into the 3R system.

Article no.	Article	Quantity	Weight	Code
FT 01729	FTool PIN center chuck IF3R	1 piece	1.60 kg	P

Delivered without chucking spigot.

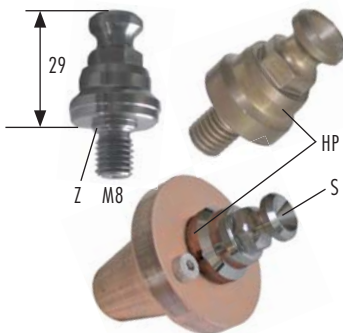
F-Tool PIN centering bolt

According to the application, the suitable centering bolts may be inserted.

HP = PIN centering bolt high precision / grinded

Z = with centering bundle

S = flushing hole

Article no.	Article	Quantity	Weight	Code
FT 01719	FTool RefPIN HP-Z with flushing S (grinded)	1 piece	0.07 kg	P
FT 01720	FTool RefPIN-Z with flushing S	Set of 10 pieces	0.65 kg	P
FT 01721	FTool RefPIN-Z without flushing S	Set of 10 pieces	0.65 kg	P
FT 01722	FTool RefPIN without bundle Z	Set of 10 pieces	0.65 kg	P
FT 01723	FTool ClampPIN (without bundle Z and without centering)	Set of 10 pieces	0.65 kg	P

F-Tool PIN index 8 mm M5

The orientation coat can be defined with the PIN index.

Article no.	Article	Quantity	Weight	Code
FT 01724	FTool PIN index Ø 8/3.5 mm M5 A2	Set of 10 pieces	0.01 kg	P

F-Tool PIN holder system



F-Tool PIN clamping holder

The PIN clamping holder is a basic holder made of aluminium for the collet of electrodes and work pieces.

Article no.	Article	Quantity	Weight	Code
FT 01725	FTool PIN clamping holder 26 mm	1 piece	0.62 kg	P

Other sizes on request.
Delivered incl. assembled PIN index, but without centering bolt.

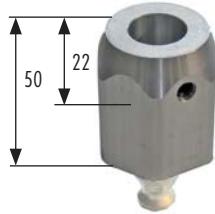

F-Tool PIN electrode spanner

The PIN electrode spanner made of aluminium is very good qualified for an economic collet of electrode blanks and the conditioning in the PIN system.

Article no.	Article	Quantity	Weight	Code
FT 01726	FTool PIN electrode spanner Ø 16 mm	Set of 10 pieces	1.80 kg	P

Other diameters on request.
Delivered incl. assembled PIN index, but without centering bolt.



F-Tool copper blank

The copper blank is assembled with a PIN index and prepared for the centering bolt.

Article no.	Article	Quantity	Weight	Code
FT 01234	FTool copper blank Ø 50 x L = 45 mm prepared for PIN adapter	Set of 10 pieces	7.66 kg	E

Other sizes on request.
Delivered incl. assembled PIN index, but without centering bolt.

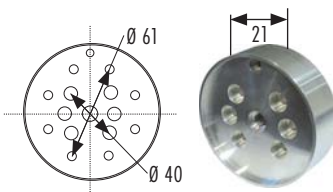

F-Tool PIN pallet aluminium

The PIN pallet aluminium is an economic, universal pallet, applicable for the collet of electrodes and work pieces.

Article no.	Article	Quantity	Weight	Code
FT 01727	FTool PIN pallet alu Ø 80 mm	1 piece	0.34 kg	P

Delivered incl. assembled PIN index, but without centering bolt.



Rustless, precision three-jawed chuck

Suitable for the application on EDM wire cutting machines under water. Hardened clamping jaws for the clamping of outside diameter Ø 1 - Ø 60 mm and inside diameter of Ø 12 - Ø 66 mm. Hole pattern 4 x M6, reference circle 40 mm.

Clamping accuracy ± 0.01 mm, maximum work piece weight: 2 kg

Article no.	Article	Quantity	Weight	Code
FT 02008	3 Jaw scroll chuck DBF63 rustless 0-56 mm Ø 70 mm L = 40 mm	1 piece	0.76 kg	P

Examples of use:

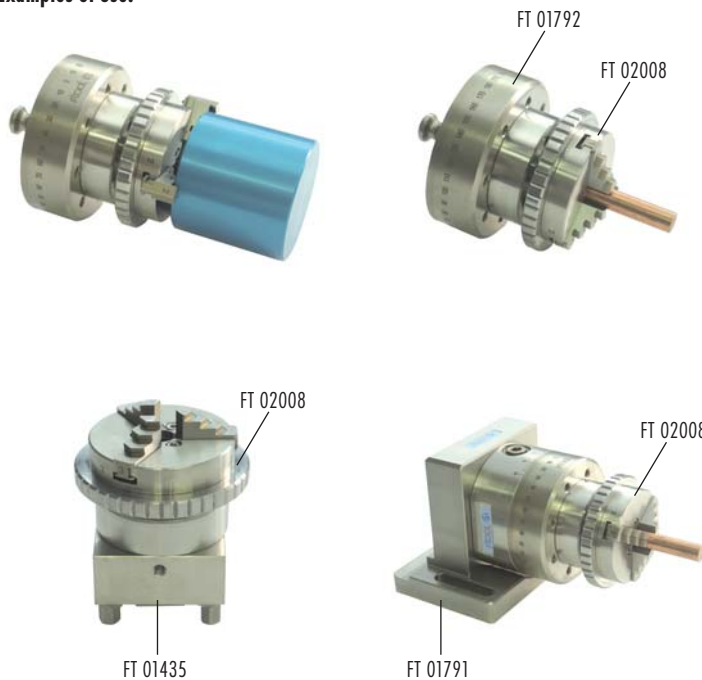
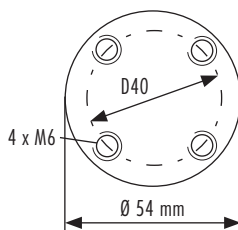

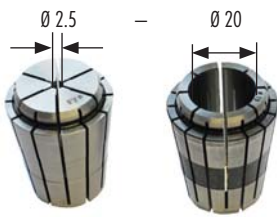
Collets ETS32

Specification: Accurate rotation from $\varnothing 2.5$ to 20 mm.
Clamping scope per collet: $\varnothing 2.5 \text{ mm} = 0.5 \text{ mm}$
 $\varnothing 3 - 20 \text{ mm} = 1 \text{ mm}$

Application: For round material from $\varnothing 2$ to 20 mm.

Article no.	Article	Quantity	Weight	Code
FT 01001	Collet set $\varnothing 2.5 - 20 \text{ mm}$ ETS32	Set of 19 pieces	2.60 kg	A
FT 01002	Collet $\varnothing 2.5 \text{ mm}$ ETS32	1 piece	0.14 kg	A
FT 01003	Collet $\varnothing 3 \text{ mm}$ ETS32	1 piece	0.14 kg	A
FT 01004	Collet $\varnothing 4 \text{ mm}$ ETS32	1 piece	0.14 kg	A
FT 01005	Collet $\varnothing 5 \text{ mm}$ ETS32	1 piece	0.14 kg	A
FT 01006	Collet $\varnothing 6 \text{ mm}$ ETS32	1 piece	0.14 kg	A
FT 01007	Collet $\varnothing 7 \text{ mm}$ ETS32	1 piece	0.14 kg	A
FT 01008	Collet $\varnothing 8 \text{ mm}$ ETS32	1 piece	0.14 kg	A
FT 01009	Collet $\varnothing 9 \text{ mm}$ ETS32	1 piece	0.13 kg	A
FT 01010	Collet $\varnothing 10 \text{ mm}$ ETS32	1 piece	0.13 kg	A
FT 01011	Collet $\varnothing 11 \text{ mm}$ ETS32	1 piece	0.13 kg	A
FT 01012	Collet $\varnothing 12 \text{ mm}$ ETS32	1 piece	0.13 kg	A
FT 01013	Collet $\varnothing 13 \text{ mm}$ ETS32	1 piece	0.12 kg	A
FT 01014	Collet $\varnothing 14 \text{ mm}$ ETS32	1 piece	0.12 kg	A
FT 01015	Collet $\varnothing 15 \text{ mm}$ ETS32	1 piece	0.11 kg	A
FT 01016	Collet $\varnothing 16 \text{ mm}$ ETS32	1 piece	0.11 kg	A
FT 01017	Collet $\varnothing 17 \text{ mm}$ ETS32	1 piece	0.10 kg	A
FT 01018	Collet $\varnothing 18 \text{ mm}$ ETS32	1 piece	0.10 kg	A
FT 01019	Collet $\varnothing 19 \text{ mm}$ ETS32	1 piece	0.09 kg	A
FT 01020	Collet $\varnothing 20 \text{ mm}$ ETS32	1 piece	0.08 kg	A

Collet chuck holder FTS 16

Application: Collet chuck holder on hardened and grinded steel $\varnothing 20 \text{ mm}$, incl. collets $\varnothing 2$ to 10 mm.

Article no.	Article	Quantity	Weight	Code
FT 01233	FTool collet chuck holder FTS 16, shaft $\varnothing 20 \text{ mm}$, incl. 11 collet chucks $\varnothing 2 - 10 \text{ mm}$ and seal kit	1 set	0.56 kg	A

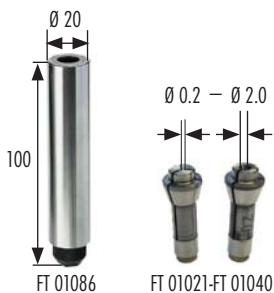
Mini collet chuck holder

Specification: Mini collet chuck holder on hardened and grinded steel $\varnothing 20 \text{ mm}$.
Mini collets from $\varnothing 0.2$ to 2 mm, grinded steel with brass seal for the appropriate diameters.

Application: Clamp of small electrode pipes $\varnothing 0.2$ to 2 mm.



Article no.	Article	Quantity	Weight	Code
FT 01086	Mini collet chuck holder for $\varnothing 0.2-2.0 \text{ mm}$ (deliv. without collet chucks)	1 piece	0.25 kg	A
FT 01021	Mini collet set $\varnothing 0.2 - 2 \text{ mm}$ F4.5	Set of 19 pieces	0.17 kg	A
FT 01022	Mini collet $\varnothing 0.2 \text{ mm}$ F4.5	1 piece	0.01 kg	A
FT 01023	Mini collet $\varnothing 0.3 \text{ mm}$ F4.5	1 piece	0.01 kg	A
FT 01024	Mini collet $\varnothing 0.4 \text{ mm}$ F4.5	1 piece	0.01 kg	A
FT 01025	Mini collet $\varnothing 0.5 \text{ mm}$ F4.5	1 piece	0.01 kg	A
FT 01026	Mini collet $\varnothing 0.6 \text{ mm}$ F4.5	1 piece	0.01 kg	A
FT 01027	Mini collet $\varnothing 0.7 \text{ mm}$ F4.5	1 piece	0.01 kg	A
FT 01028	Mini collet $\varnothing 0.8 \text{ mm}$ F4.5	1 piece	0.01 kg	A
FT 01029	Mini collet $\varnothing 0.9 \text{ mm}$ F4.5	1 piece	0.01 kg	A
FT 01030	Mini collet $\varnothing 1.0 \text{ mm}$ F4.5	1 piece	0.01 kg	A
FT 01031	Mini collet $\varnothing 1.1 \text{ mm}$ F4.5	1 piece	0.01 kg	A
FT 01032	Mini collet $\varnothing 1.2 \text{ mm}$ F4.5	1 piece	0.01 kg	A
FT 01033	Mini collet $\varnothing 1.3 \text{ mm}$ F4.5	1 piece	0.01 kg	A
FT 01034	Mini collet $\varnothing 1.4 \text{ mm}$ F4.5	1 piece	0.01 kg	A
FT 01035	Mini collet $\varnothing 1.5 \text{ mm}$ F4.5	1 piece	0.01 kg	A
FT 01036	Mini collet $\varnothing 1.6 \text{ mm}$ F4.5	1 piece	0.01 kg	A
FT 01037	Mini collet $\varnothing 1.7 \text{ mm}$ F4.5	1 piece	0.01 kg	A
FT 01038	Mini collet $\varnothing 1.8 \text{ mm}$ F4.5	1 piece	0.01 kg	A
FT 01039	Mini collet $\varnothing 1.9 \text{ mm}$ F4.5	1 piece	0.01 kg	A
FT 01040	Mini collet $\varnothing 2.0 \text{ mm}$ F4.5	1 piece	0.01 kg	A

Clamping elements, swivel block and vises



Clamping elements and interface plates

Adapter for vise 20VL24.

Article no.	Article	Quantity	Weight	Code
FT 01321	FTool vise 20VL24	1 piece	0.26 kg	W
FT 01343	FTool Interface uniplate for vise 20VL24	1 piece	0.22 kg	W
FT 01435	FTool ER-plate EWIS	Set of 10 pieces	4.50 kg	A

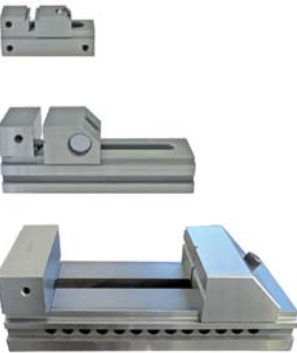

F-Tool vises

Accurate vises made of rustless, hardened, grinded high-grade steel for grinding machines, EDM-, wire EDM- and EDM drilling- machines.

Dimensions FT 01321 (mm): A=20 B=20 C=25 D=24 E=30 F=10 G=64.5 H=19.5

Dimensions FT 01320 (mm): A=25 B=75 C=40 D=50 E=52.5 F=25 G=140 H=28

Dimensions FT 01591 (mm): A=50 B=200 C=90 D=150 E=100 F=50 G=330 H=50

Article no.	Article	Quantity	Weight	Code
FT 01321	FTool vise 20VL24	1 piece	0.26 kg	W
FT 01320	FTool vise 80VL50	1 piece	1.40 kg	W
FT 01591	FTool precision vise 200VL150 rustless steel	1 piece	22.00 kg	B

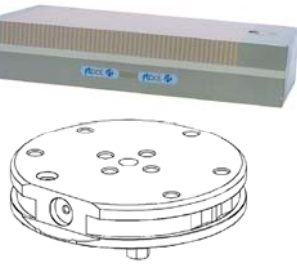
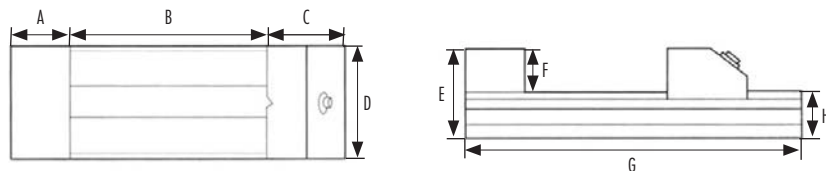

Magnetic table 250 x 150mm (prepared PIN and ITS 148)

This magnetic table is compatible with the EROWA standard pallets \varnothing 148 mm.

Article no.	Article	Quantity	Weight	Code
FT 01824	Magnetic table 250 x 150 mm (prepared PIN and ITS 148 mm)	1 piece	15.70 kg	B

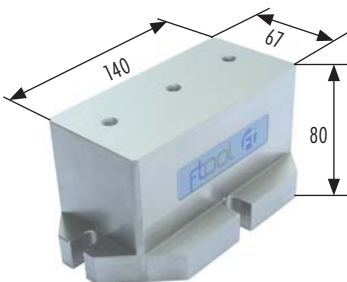

Clamping block

The Clamping block can be used as a basement on the EDM, EDM-drilling and Presetting machines. On the top surface the FT 01347 Basic Ruler 140 mm can be fitted. The clamping block is a high accurate clamping surface for workpieces and fixtures for RulerSet equipments.

Article no.	Article	Quantity	Weight	Code
FT 01945	Clamping block h80	1 piece	6.78 kg	B
FT 01347	FTool basic ruler 140 mm	1 piece	1.75 kg	W

Combination examples:

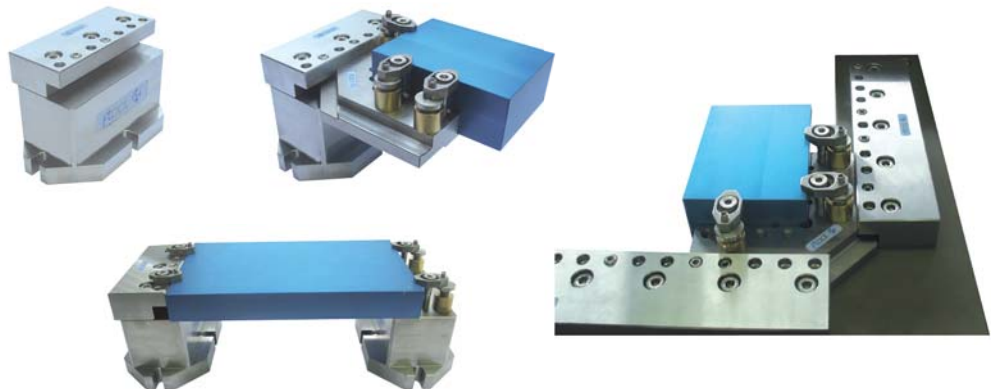



F-Tool 5S-PowerSet

The 5S-PowerSet is a wide clamping element set, suited for the 5-side machining of work pieces on 3-axis milling machines. The set contains:

- 1 x FT 01483 Square block chuck 80/PIN chuck with 2 x FT 01043 FTool ER chuck 80P
- 1 x FT 01811 FTool PIN MultiClamp 181 x 72 mm B40, corrosion-resistant
- 2 x FT 01949 FTool Pallet PP148 alu (Power Plate)
- 2 x FT 01835 FTool ER-PowerPlate (individual centering plate for pallets and fixtures)
- 4 x FT 01074 Chucking spigot F/M long without flushing

Article no.	Article	Quantity	Weight	Code
FT 02003	FTool 5S-PowerSet	1 Set	18.60 kg	P



F-Tool ER-PowerPlate

Centering plate with P-profile, compatible with FT 01043 FTool ER chuck 80P plus all EROWA chucks with P-profile, EROWA PowerChuck and EROWA ProductionChuck 210 Combi. Highly friction centering. For the direct assembling on pallets and fixtures.

Article no.	Article	Quantity	Weight	Code
FT 01835	FTool ER-PowerPlate	1 piece	0.27 kg	P

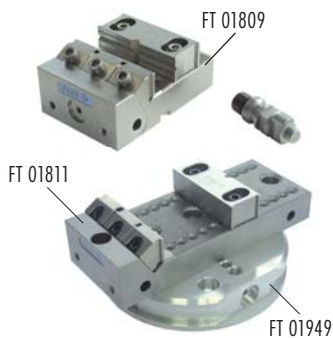

F-Tool Pallet ER-PP148 alu (PowerPlate)

The F-Tool pallet is equipped with the F-Tool PowerPlate and can be used on all EROWA chucks with P centering. For the collet of fixtures and work pieces, the pallet with hole pattern 4 x Ø 9/110 x 50/4 x Ø 9/TK37A) and 4 x M8/D80 is prepared for the assembling of the F-Tool MultiClamp FT 01809 and FT 01811.

Article no.	Article	Quantity	Weight	Code
FT 01809	FTool PIN MultiClamp 105 x 72 mm B40, corrosion-resistant	1 piece	1.90 kg	P
FT 01810	FTool PIN MultiClamp 105 x 72 mm ITS50, corrosion-resistant	1 piece	1.95 kg	P
FT 01811	FTool PIN MultiClamp 181 x 72 mm B40, corrosion-resistant	1 piece	2.94 kg	P
FT 01949	FTool Pallet ER-PP148 alu (Power Plate)	1 piece	1.41 kg	P



F-Tool T-nut ER-P-Pallet with handles

The F-Tool PP-pallet with handles can be used perfectly on EROWA chucks with P-profile. The T-nut pallet is suited for the collet of work pieces and fixtures. The pallets are equipped with the PowerPlate FT 01835.

Article no.	Article	Quantity	Weight	Code
FT 02004	FTool T-slot PP-Palette 150 x 150 mm	1 piece	2.40 kg	P
FT 02005	FTool T-slot PP-Palette 280 x 180 mm	1 piece	4.30 kg	P
FT 02006	FTool Universal-PP-Palette 280 x 180 mm	1 piece	4.90 kg	P



F-Tool PIN BrassClamp

The F-Tool PIN BrassClamp is a brass retainer with hardened, corrosion-resistant pull-down jaws. If necessary, the stop surface on the holder can be milled to approx. 28 mm. The BrassClamp is supplied as standard with 3 clamping jaws with a clamping range of 0-3 mm. The BrassClamp is suited for use as an electrode (in particular graphite) retainer. However, it can also be used as a precision parts clamp, because the brass jaw can be enlarged precisely.

B40 = prepared for PIN system, 3R adapter plate, T-nuts and grid plate 40 mm/M8. Delivered with screws.
ITS 50 = equipped with ITS centering plate 50 / EWIS preparation. Delivered with ITS chucking spigot F/A.

Article no.	Article	Quantity	Weight	Code
FT 01807	FTool PIN BrassClamp 72 x 72 mm B40	1 piece	1.85 kg	P
FT 01808	FTool PIN BrassClamp 72 x 72 mm ITS50	1 piece	2.00 kg	P



Hydraulic Spanner 32

The Hydraulic Spanner is suitable for the concentric collet of electrodes or work pieces with a shank diameter of 32 mm. Other diameters can be clamped with suitable reduction plugs. It can be assembled on the ER adapter (FT 01435) or on every other cutting site with 4 or 2 x M6 on circle diameter 40 mm. The rustless execution is able for the water bath.

Article no.	Article	Quantity	Weight	Code
FT 01732	FTool Hydraulic Spanner 32	1 piece	1.70 kg	B

Clamping sleeves

The reduction plugs of rustless steel can be inserted into the Hydraulic Spanner.



Article no.	Article	Quantity	Weight	Code
FT 01733	Reduction plug 10 mm for Hydraulic Spanner 32	1 piece	0.35 kg	B
FT 01734	Reduction plug 12 mm for Hydraulic Spanner 32	1 piece	0.35 kg	B
FT 01735	Reduction plug 16 mm for Hydraulic Spanner 32	1 piece	0.35 kg	B
FT 01736	Reduction plug 20 mm for Hydraulic Spanner 32	1 piece	0.35 kg	B
	other diameters on request			

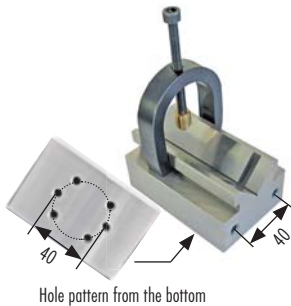

F-Tool V-block stainless steel

The V-Block is qualified for the fast clamping of arbors, punches and pushers up to $\varnothing 32$ mm. It can be assembled frontally or from the back on diverse F-Tool holders. The best compatibility is with the uniplate EWIS (FT 01080), the F-Tool ER-plate EWIS (FT 01435), the F-Tool basic plate IF3R (FT 01135) and the F-Tool universal index adapter plate 80 with nonius-display (FT 01579). For the application on EDM, WEDM and grinding machines.

Article no.	Article	Quantity	Weight	Code
FT 01679	FTool V-block rust-resistant	1 piece	1.64 kg	W



Collet chuck holder ETS32

The collet chuck holder ETS32 is rust-resistant and able for the water bath.

Article no.	Article	Quantity	Weight	Code
FT 01581	FTool collet chuck holder ETS32 without adapter plate (corrosion-resist.)	1 piece	0.45 kg	A



Clamping unit ER/3R chuck 80

Spare part for the ER chuck 80P and the F-Tool chuck 80 IF3R.

Article no.	Article	Quantity	Weight	Code
FT 01582	Clamping unit ER/IF3R chuck 80	1 piece	0.45 kg	A



Chucking spigot clip open

For the insertion on the ITS electrode holder in the electrode changer with EROWA gripper.

Article no.	Article	Quantity	Weight	Code
FT 01090	Chucking spigot clip open	Set of 20 pieces	0.10 kg	B



Sealing washer

Application: Insertion in prisround for sealing on central flushing.

Article no.	Article	Quantity	Weight	Code
FT 01093	Sealing washer	Set of 24 pieces	0.16 kg	C



O-Ring for rapid-action chuck

Application: Sealing between chucking spigot and rapid-action chuck.

Article no.	Article	Quantity	Weight	Code
FT 01099	O-ring for rapid-action chuck	Set of 50 pieces	0.05 kg	C



Ring piece

Spare part for EROWA chucking spigots.

Article no.	Article	Quantity	Weight	Code
FT 01100	Ring piece	1 piece	0.01 kg	C

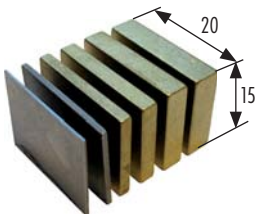

Insert plates 0.5 / 1 / 2 / 3 / 4 / 5 mm

Version: Corrosion-resistant, thicknesses from 0.5 to 5 mm.

Application: Centering of blanks in electrode holders.

Article no.	Article	Quantity	Weight	Code
FT 01092	Insert plates 0.5 / 1 / 2 / 3 / 4 / 5 mm	Set of 300 pieces	2.10 kg	C

Construct your individual equipment on the basis of your interfaces.

F-Tool Ruler Set Wire Tooling

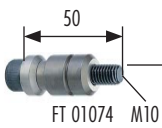
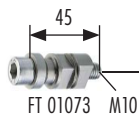
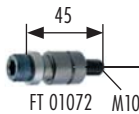
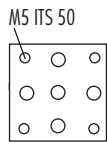
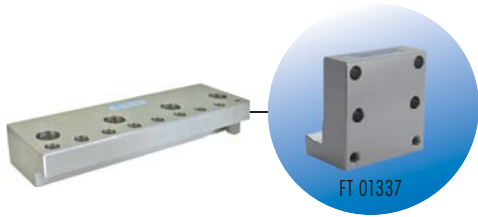

EROWA link

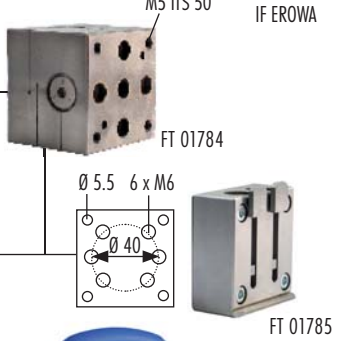
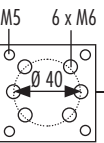
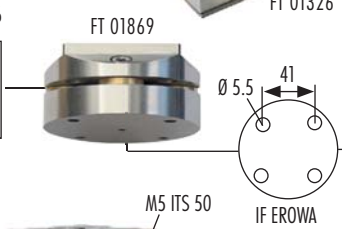
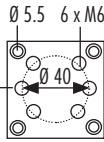
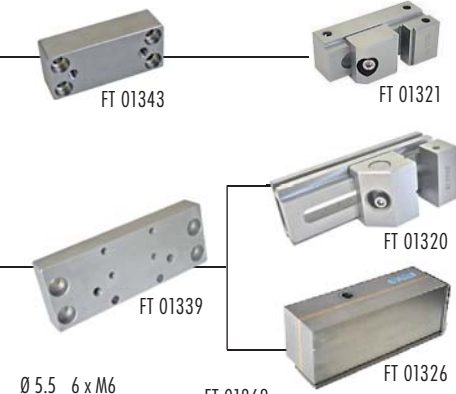
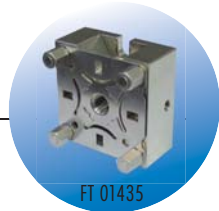

IF3R link

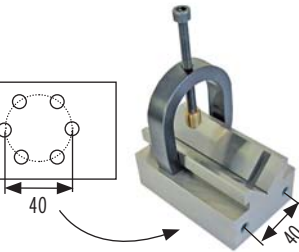
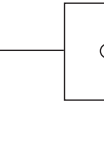
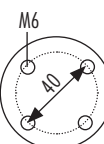
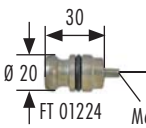
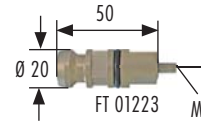
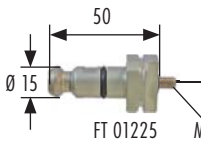
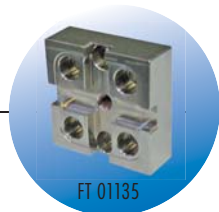

F-Tool PIN System

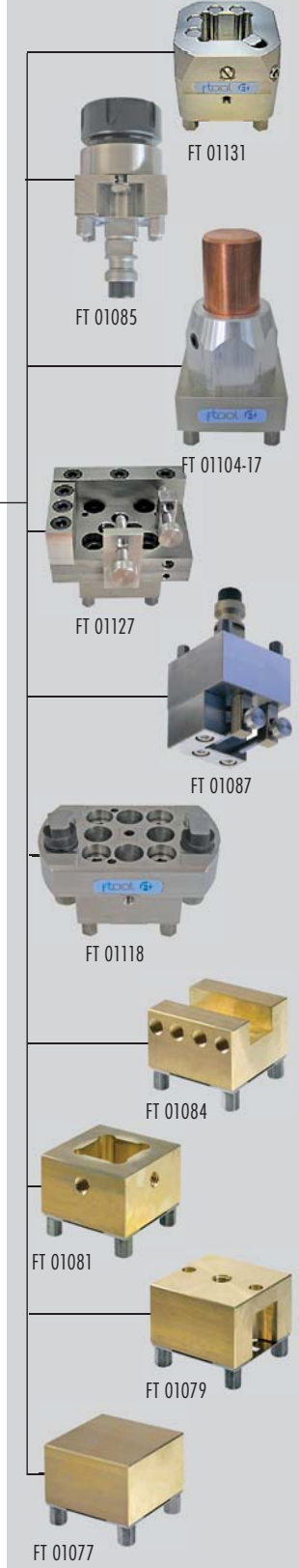
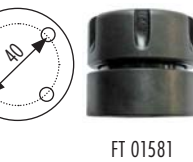
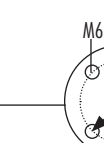

F-Tool International AG - General Terms and Conditions of Delivery

1. General

1.1 The purchase contract will be concluded by a written order and the written order confirmation from the supplier. Offers which do not include a deadline for acceptance will not be binding.

2. Scope of the goods and services

2.1 The supplier's goods and services will be listed in the order confirmation. The supplier will anytime be entitled to modify products in order to improve them.

3. Plans, photographs and technical documents

3.1 In the absence of any agreement to the contrary, brochures and catalogues will not be binding. Details in technical documents will only be binding if they are expressly guaranteed. Some products are procured from selected first-class sub-suppliers. Published pictures or versions may differ from the sales documents.

4. Regulations in the destination country and safeguards

4.1 The purchaser must inform the supplier of the regulations and standards of the country of destination relating to the provision of goods and services, the business and health and safety at work, at the latest when placing the order.

4.2 In the absence of any agreement to the contrary, the goods and services will comply with regulations and standards at the registered office of the purchaser, of which the purchaser has informed the supplier in accordance with no. 4.1. Additional or other safeguards will also be provided insofar as this has been agreed.

5. Prices

5.1 The price list valid on the date of the order will determine the prices. In the absence of any agreement to the contrary, all prices will be net, ex works, and exclusive of carriage, customs clearance, packaging and VAT and in Swiss Francs or euros, net of any deduction (EXW).

The purchaser will be responsible for all incidental costs, e.g. for freight, insurance, export, transit, import and other licenses and certification. The purchaser will also be responsible for all taxes, charges, fees, duty, etc. of any nature whatsoever which may be raised in connection with the contract or refund them to the supplier on production of corresponding evidence, if the latter has become liable for payment thereof.

5.2 The supplier reserves the right to amend the prices, should there be a change in rates of pay, prices of materials or suppliers' prices between the date of the order and performance in accordance with the contract.

6. Payment terms

6.1 In the absence of any express agreement, prepayment will be due upon readiness to delivery.

6.2 Otherwise, the payment deadline for contracting partners will be 30 days net from the date of the invoice, in the absence of any agreement to the contrary. In the event of arrears of payment, the purchaser must anticipate 8% interest on arrears from the date on which payment is due. The right to claim further compensation remains reserved.

7. Reservation of title

7.1 The supplier will retain title to all its goods until it has received full payments in accordance with the contract. The purchaser authorises with the signing of the order and so the acceptance of these General Terms and Conditions of Delivery the supplier, if necessary with the regulations of the country of destination, to register such a retention of title in the appropriate register.

8. Delivery date / delivery conditions

8.1 The supplier will endeavour to deliver the standard products from stock on a specific date. The purchaser must refer to the order confirmation for deliveries with delivery dates.

8.2 The EXW delivery terms must be interpreted in accordance with the current applicable Incoterms (currently Incoterms 2000).

8.3 The purchaser will have no rights or claims to remuneration as a result of goods or services being late. However, it reserves the right to cancel the contract.

8.4 The minimum charge for goods or services is CHF 50.00.

9. Packaging

9.1 The supplier will issue a separate invoice for packaging.

10. Inspection and acceptance of goods and services

10.1 Insofar as is standard practice, the supplier will inspect the goods and services prior to despatch and guarantees that they are complete and of good quality.

10.2 The purchaser must inspect the goods and services within a reasonable period and notify the supplier of any detected defects in writing without delay. Should it fail to do so, the goods and services will be deemed to have been accepted.

10.3 The purchaser has a 30-day return, exchange or money-back guarantee for standard list products.

This concerns all standard list products which are purchased regularly, not customized, not used or modified and in their complete, original packaging.

The purchaser will be responsible for the return freight costs.

11. Guarantee, liability for defects

11.1 The *guarantee period* is 30 days, as stated in no. 10.3, in the absence of any stipulation to the contrary in the delivery documents or in legislation. The period starts at the date of delivery, respective with the writing of the delivery note.

11.2 Liability for material defects, design flaws or shortcomings in implementation

The supplier undertakes to repair or replace any parts of its goods which verifiably become defective or unusable as a result of material defects, design flaws or shortcomings in completion up to the end of the guarantee period, as soon as possible on written demand by the purchaser. Characteristics are only warranted, if they are mentioned expressly in the order confirmation or in the specifications. The confirmation counts until the expiration of the guarantee period. Are the warranted characteristics not, or only partially fulfilled, the purchaser has the right of immediate amendment of the supplier. For this, the purchaser has to afford the supplier the needed time and opportunity.

11.3 Exclusions of liability for defects

Damage will be excluded from the supplier's guarantee if it is not verifiably a consequence of poor material, design flaws or shortcomings in completion, e.g. a result of wear and tear, poor maintenance, failure to observe operating instructions, overloading, inappropriate operating resources, chemical or electrolytic effects, structural or installation work not carried out by the supplier, and other reasons for which the supplier is not responsible.

11.4 Sub-suppliers' goods and services

The supplier will only guarantee goods and services of sub-suppliers within the scope of the guarantee obligations of the sub-suppliers in question.

12. Exchange procedure

12.1 Should the goods supplied not comply with the guarantee undertaking of the supplier / manufacturer / sub-supplier, or should the delivery be incomplete, the following steps must be taken:

- The supplier must be contacted and claims asserted in writing under guarantee for defects or missing or wrongly delivered parts.
- All returns will undergo a strict incoming goods inspection. Returned goods must be complete, in the original packaging and be accompanied by the appropriate documents, fault reports, guarantee cards and accessories.

12.2 The purchaser will be responsible for the return freight costs.

12.3 15% of the list price plus repair costs will be charged for outlay for returns which are incomplete or are not defective.

12.4 Replacement parts will be charged as standard and the returns credited with a 'Credit Note' after inspection.

13. Preclusion of further liability by the supplier

13.1 All cases of breach of contract and their legal consequences, and all claims by the customer, irrespective of the legal basis on which they are asserted, are covered conclusively by these terms and conditions. In particular, all claims for compensation, a reduction and cancellation of the contract which are not expressly stipulated are excluded. Under no circumstances will claims for compensation by the customer be valid for damage which does not occur to the delivered item itself, such as loss of production, use, orders, profit or other direct or indirect losses. Preclusion of liability will not apply to unlawful intent or gross negligence of the supplier, but will also apply to unlawful intent or gross negligence of ancillary persons. In other respects, this preclusion of liability will not apply if it is contrary to legislation.

14. Court of jurisdiction and applicable law

14.1 **The court of jurisdiction for the customer and the supplier will be the registered office of the supplier.**

However, the supplier will be entitled to take legal action against the customer at its registered office.

14.2 The legal relationship will be governed by substantive Swiss law.

See for yourself. To meet your practical circumstances you are only one «click» away from us.

Visit our homepage at
www.f-tool.com

Head office:

F-Tool International AG • Oberdorf 6 • P.O. Box • CH-5040 Schöftland • Switzerland •
Phone +41 (0)62 739 00 30 • Fax +41 (0)62 739 00 39 • E-Mail: info@f-tool.com

Subsidiary in Germany:

F-Tool GmbH • Gewerbepark Breisgau • Freiburger Strasse 19 • DE-79427 Eschbach •
Phone +49 (0)7634/504883-0 • Fax +49 (0)7634/504883-15 • E-Mail: info@f-tool.de

Subsidiary in Thailand:

F-Tool (Thailand) Co., Ltd. • 12/3 Moo 10 • Klong-Khoi, Pak-Kred • Nonthaburi 11120 • Thailand •
Phone +66 (0)84 757 66 62-3 • Fax +66 (0)81 838 21 40 • E-Mail: ftoolth@ksc.th.com